

CD-206/DPF-R6010/R6010E SERVICE MANUAL

© 1998-3/B51-5418-00 (K/K) 3430

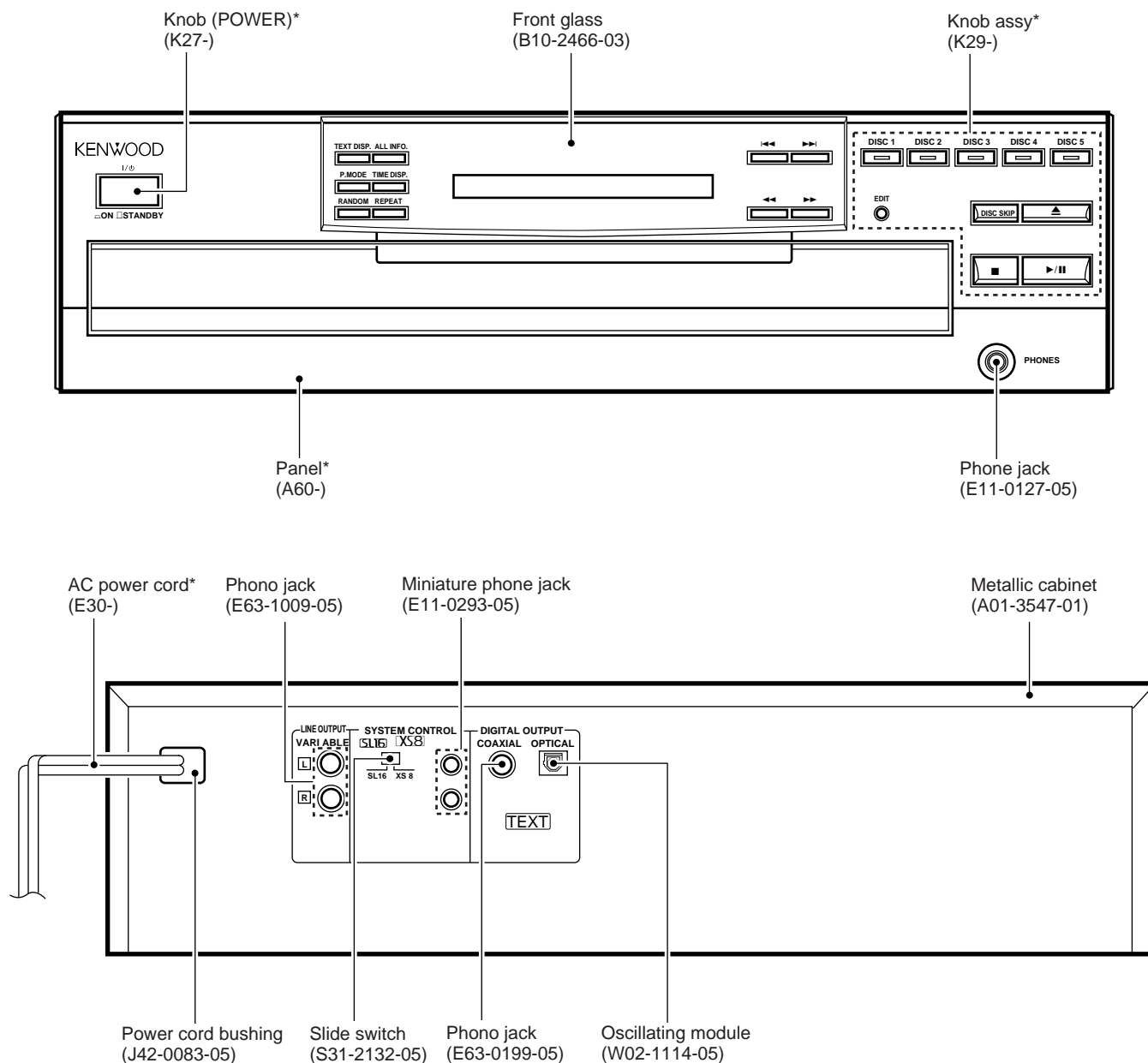

* Refer to parts list on page 18 .

In compliance with Federal Regulations, following are reproductions of labels on, or inside the product relating to laser product safety.

KENWOOD-Crop. certifies this equipment conforms to DHHS Regulations No. 21 DFR 1040. 10, Chapter 1, Subchapter J.

**DANGER : Laser radiation when open and interlock defeated.
AVOID DIRECT EXPOSURE TO BEAM**

CD-206/DPF-R6010/R6010E

CONTENTS / ACCESSORIES

Contents

CONTENTS / ACCESSORIES	2	SCHEMATIC DIAGRAM	11
CIRCUIT DESCRIPTION	3	EXPLODED VIEW	16
ADJUSTMENT	6	PARTS LIST	18
PC BOARD	7	SPECIFICATIONS	Back cover

Accessories

Audio cord (1)
(E30-0505-05)

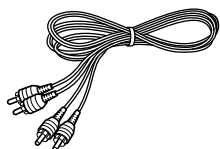

System control cord (1)
(E30-2733-05)

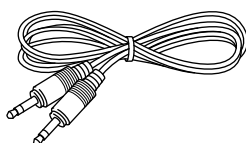

AC plug adapter (1)
(E03-0115-05) : M type only

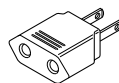

Batteries (R6/AA) (2)

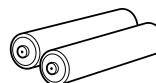

Remote control unit (1)
(A70-1134-05) : RC-P0601

Battery cover: (A09-0356-08)

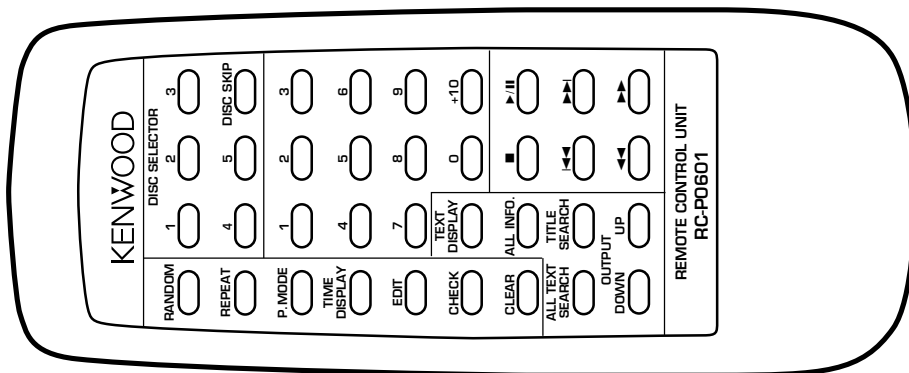

CIRCUIT DESCRIPTION

1. Microprocessor : uPD78055GC-A03 (X32, IC3)

1-1 Microprocessor periphery block diagram

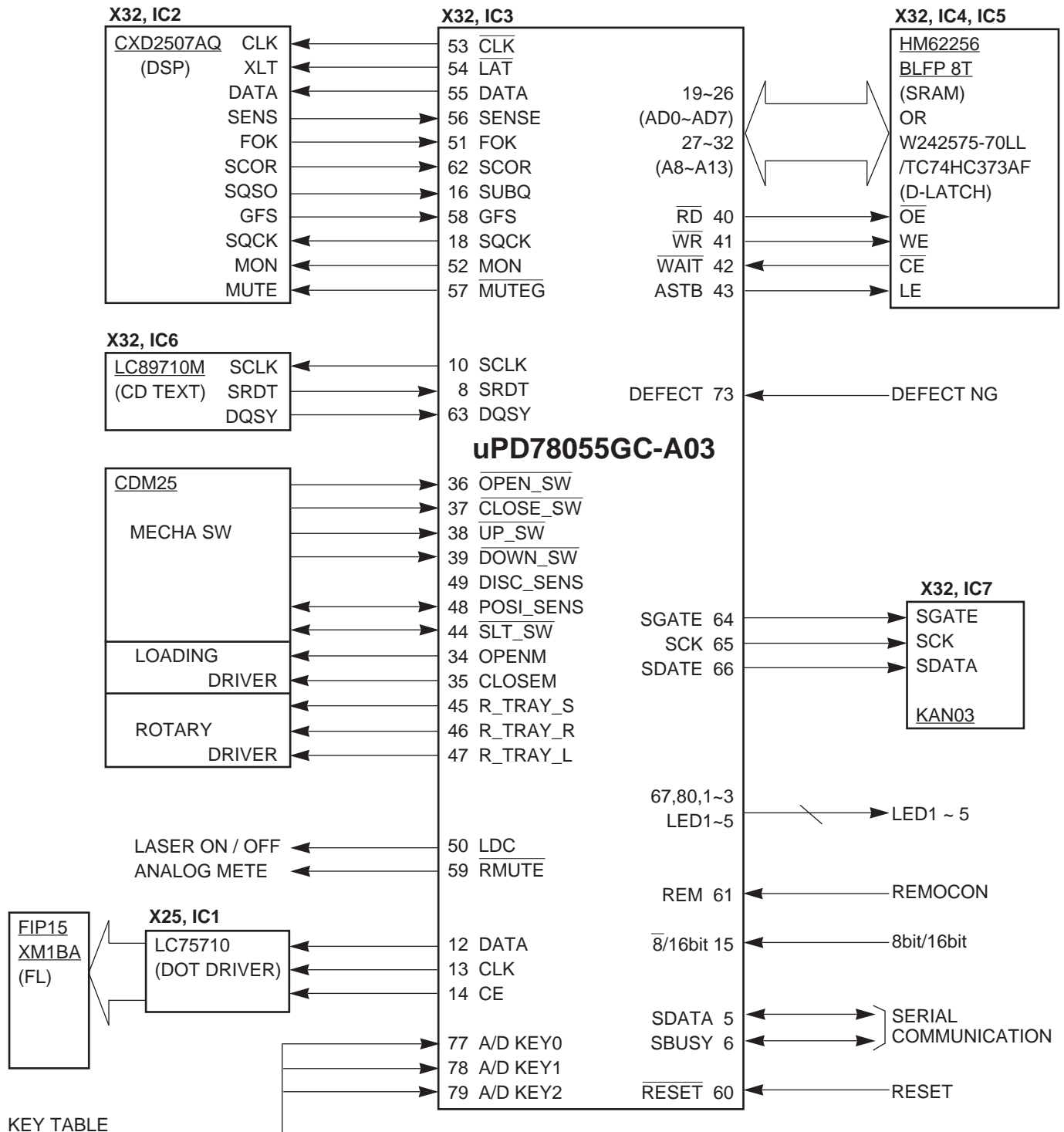

KEY TABLE

PORT (V)	A/D KEY0 (77PIN)	A/D KEY1 (78PIN)	A/D KEY2 (79PIN)
4.9 ~ 4.4	UP	DISC1	TEXT DISPLAY
4.4 ~ 3.8	DOWN	DISC2	ALL INFO.
3.8 ~ 3.2	FF	DISC3	P. MODE
3.2 ~ 2.5	FB	DISC4	TIME DISPLAY
2.5 ~ 1.9	EDIT	DISC5	RANDOM
1.9 ~ 1.3	DISC SKIP	OPEN/CLOSE	REPEAT
1.3 ~ 0.6	-	PLAY/PAUSE	-
0.6 ~ 0.2	-	STOP	-

CIRCUIT DESCRIPTION

1-2 Pin description

Pin No.	Name	I/O	Description	
1	LED3	O	DISC3 IN/OUT.	H : LED lights-ON (Disc IN)
2	LED4	O	DISC4 IN/OUT.	H : LED lights-ON (Disc IN)
3	LED5	O	DISC5 IN/OUT.	H : LED lights-ON (Disc IN)
4	AVss	-	Vss (GND).	
5	S.DATA	I/O	Serial DATA signal input/output.	
6	S.BUSY	I/O	Serial BUSY signal input/output.	
7	AVref1	I	Vdd (+5V).	
8	SRDT	I	LC89710M (CD TEXT decoder) DATA input.	
9	NC	O	No used.	
10	SCLK	O	LC89710M (CD TEXT decoder) CLOCK output.	
11	STANDBY	O	No used.	H : LED lights-ON
12	DATA	O	LC75710 (DOT driver) DATA output.	
13	CLK	O	LC75710 (DOT driver) CLOCK output.	
14	CE	O	LC75710 (DOT driver) CE output .	
15	8/16bit	I	8bit/16bit change-over.	H : 16bit
16	SUBQ	I	Q data input.	
17	NC	O	No used.	
18	SQCK	O	Q data CLOCK output.	
19-26	AD0 - AD7	I/O	HM62256BLFP12T (SRAM) ADR/DATA input/output.	
27-32	A8 - A13	O	HM62256BLFP12T (SRAM) ADRESS output.	
33	Vss	-	GND.	
34	OPEN MOTOR	O	Tray motor control [OPEN].	H : OPEN/T.U.DOWN
35	CLOSE MOTOR	O	Tray motor control [CLOSE].	H : CLOSE/T.U.UP
36	OPEN SW	I	Tray open SW input.	L : OPEN
37	CLOSE SW	I	Tray closure SW input.	L : Closure
38	UP SW	I	Mechanism up SW input.	L : UP
39	DOWN SW	I	Mechanism down SW input.	L : Down
40	RD	O	Read strobe signal output.	
41	WR	O	Write strobe signal output.	
42	WAIT	I	External waiting signal input (No used).	
43	ASTB	O	Address strobe signal output.	
44	SLT SW	I	Start limit SW input.	
45	R_TRAY_S	O	Rotary tray motor control.	L : Deceleration
46	R_TRAY_R	O	Rotary tray motor control.	H : CCW
47	R_TRAY_L	O	Rotary tray motor control.	H : CW
48	DISC_SENSE	I	Disc sensor.	H : Disc-IN
49	POSI_SENSE	I	Position sensor.	L : Detection position
50	LDC	O	Laser signal output.	L : Laser diode ON
51	FOK	I	F. OK input from CXD2507AQ.	
52	MON	O	Spindle motor ON/OFF change-over to CXD2507AQ.	
53	CLK	O	CLOCK output to CXD2507AQ.	
54	LATCH	O	LATCH output to CXD2507AQ.	
55	DATA	O	DATA output to CXD2507AQ.	
56	SENSE	I	SENSE input from CXD2507AQ.	
57	MUTEG	O	Digital mute control.	
58	GFS	I	GFS input from CXD2507AQ.	
59	RMUTEG	O	Analog mute control.	
60	RESET	I	Reset input.	

CIRCUIT DESCRIPTION

Pin No.	Name	I/O	Description
61	REM	I	Remocon signal input.
62	SCOR	I	Sub code frame sync detection signal.
63	DQSY	I	Text data reading permission signal input.
64	SGATE	O	DATA output to KAN03.
65	SCK	O	CLOCK output to KAN03.
66	SDATA	O	Enable output to KAN03.
67	LED1	O	DISC1 IN/OUT. H : LED lights-ON (Disc IN)
68	Vdd	-	Power supply (+5V).
69	X2	-	System clock input.
70	X1	I	System clock input.
71	IC	-	GND.
72	XT2	-	No used.
73	GND	-	GND.
74	AVdd	-	Vdd.
75	AVref0	I	Vdd.
76	A3	-	No used
77-79	A/D KEY0-KEY2	I	A/D key input.
80	LED2	O	DISC2 IN/OUT. H : LED lights-ON

2. Test mode

2-1 Setting the test mode

- The microprocessor built in the unit can be put to TEST MODE by just pressing the RANDOM key when set to power on.

2-2 Key vs Function in test mode

keys	Display	Description	Remarks
(Keep to press RANDOM key and AC ON)	03 :		Setting the test mode
PLAY/PAUSE ►	03 :	(1) Focus servo ----- ON (2) Tracking servo -- OFF (3) Feed servo ----- OFF	TE-balance adjustment
	► 05 00 : 00	(1) Focus servo ----- ON (2) Tracking servo ---- ON (3) Feed servo ----- ON	Focus gain / Tracking gain and FE-balance adjustment
UP ►►			
FF ◀◀	FEED OUT	Move the pick-up to the direction of the outer circumference.	
FB ►►	FEED IN	Move the pick-up to the direction of the inner circumference.	
STOP ■	TEST 00	Disc will be stopped.	
	8 BIT SYNC 16 BIT SYNC	8 bit sync and 16 bit sync will be displayed by changing the SL16/XS8 switch on the rear panel.	
RANDOM		Change the output level cyclically. 	
DOWN ◀◀	► 01	Cancellation of the test mode and 01 play.	

CD-206/DPF-R6010/R6010E

ADJUSTMENT

No.	ITEM	INPUT SETTINGS	OUTPUT SETTINGS	PLAYER SETTINGS	ALIGNMENT POINTS	ALIGN FOR	FIG.
Step 1~4 are in TEST MODE							
1	LASER POWER	—	Apply the sensor section of optical power meter on the pickup lens.	While pressing the RANDOM key, turn the AC ON. (Test mode) Press the PLAY/PAUSE key, then confirm that the display is "03".	—	On the power from 0.08 to 0.15 mW, when the diffraction grating is correctly aligned with the RF level of 1.0 Vp-p or more.	(a)
2	TRACKING ERROR BALANCE	Test disc Type 4	Connect an oscilloscope as follows. CH1 : RF (CN2 pin 1) CH2 : TE (CN2 pin 6)	Press the PLAY/PAUSE key, then confirm that the display is "03".	TE BALANCE VR2	Symmetry between upper and lower patterns	
3	FOCUS ERROR BALANCE	Test disc Type 4	Connect an oscilloscope as follows. CH1 : RF (CN2 pin 1) CH2 : FE (CN2 pin 2)	Press the PLAY/PAUSE key, then confirm that the display is "05".	FE BALANCE VR1	Optimum eye pattern	
4	TRACKING GAIN	Test disc Type 4 Apply signal of 1.2 kHz, 50mVrms to CN2 pin 5-6.	Connect a LPF to CN2 pin 5-6 to which you connect an oscilloscope or AC voltmeters.	Press the PLAY/PAUSE key, then confirm that the display is "05".	TRACKING GAIN VR3	Two VTVMs should read the same value.	(e)

Note:

Type 4 disc : SONY YEDS-18 Test Disc or equivalent.

LPF: Around 47 kΩ+ 390 pF or so.

(a) Laser power

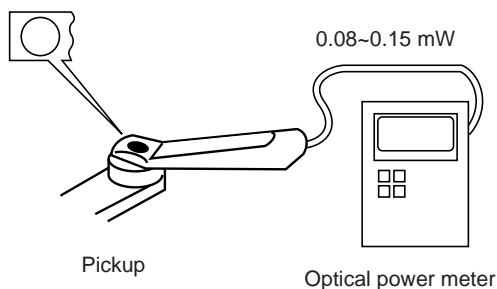

(e) Tracking gain

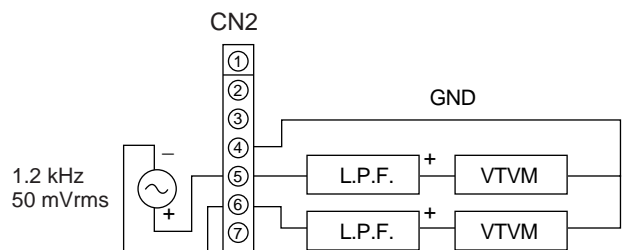

PC BOARD(Component side view)

CD player unit (X32-333x-xx)

0-13 : DPF-R6010/R6010E (XTEE2)
 CD-206
 0-24 : DPF-R6010

(M) X32 D/6

X32-3330-XX A/6

X32 E/6

X32 F/6

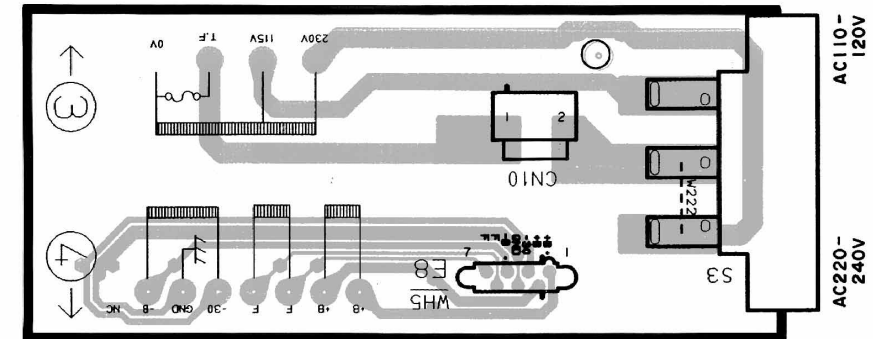
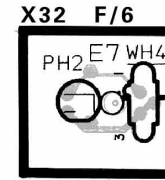
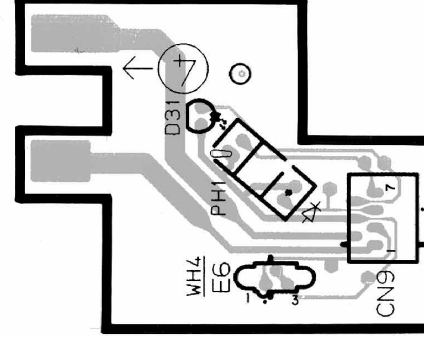
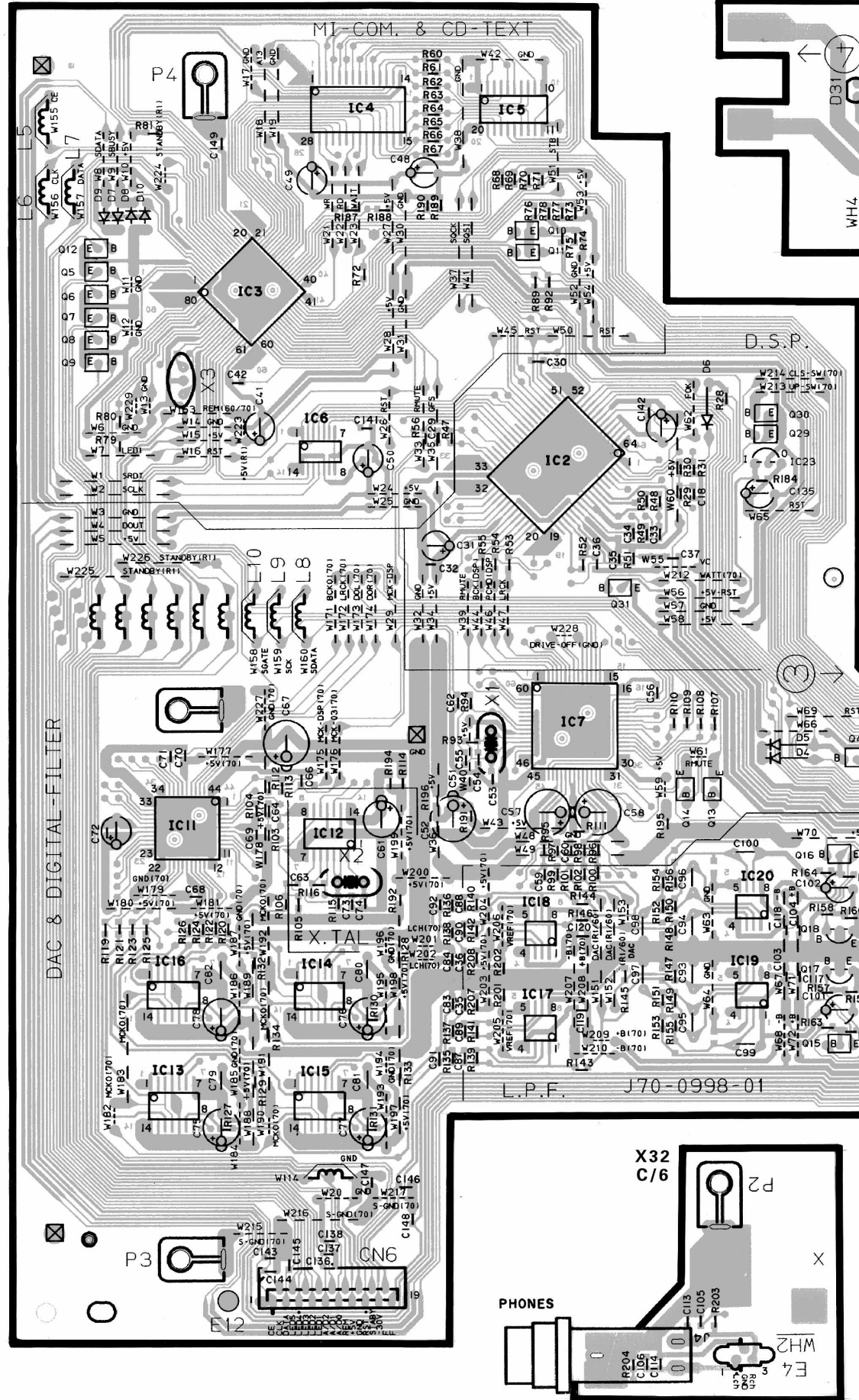

X32 B/6

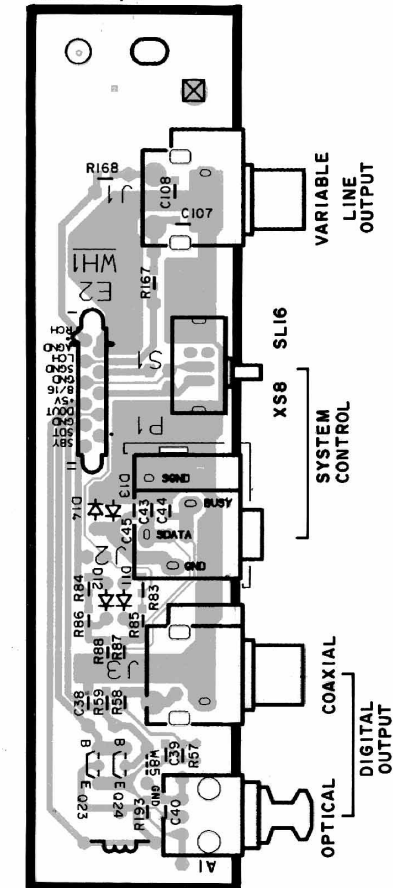

PC BOARD(Component side view)

Display unit (X25-5900-10)

X25-5900-10 A/3

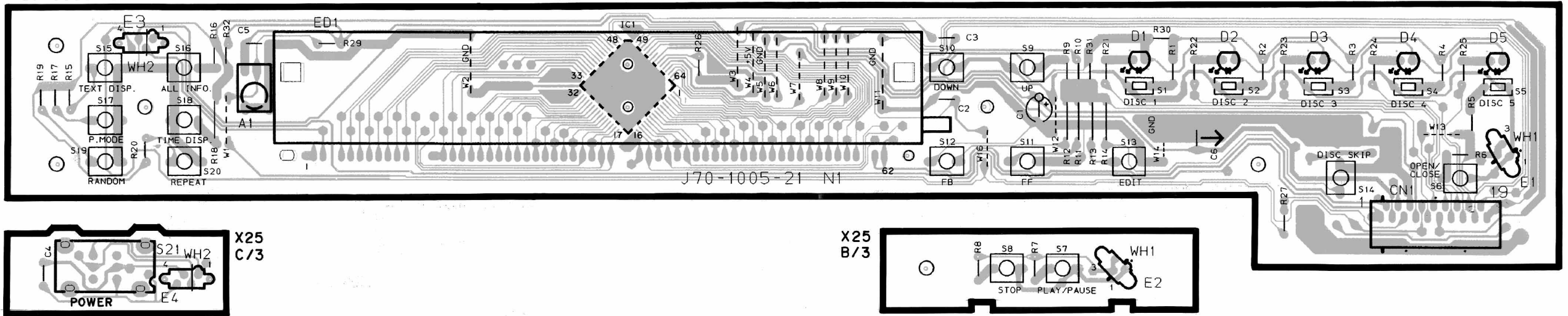

MECHA. ASS'Y (CDM-25)
(X92-1930-10/X92-1960-91)

CD PLAYER UNIT
(X32-3330-XX) (A/6)

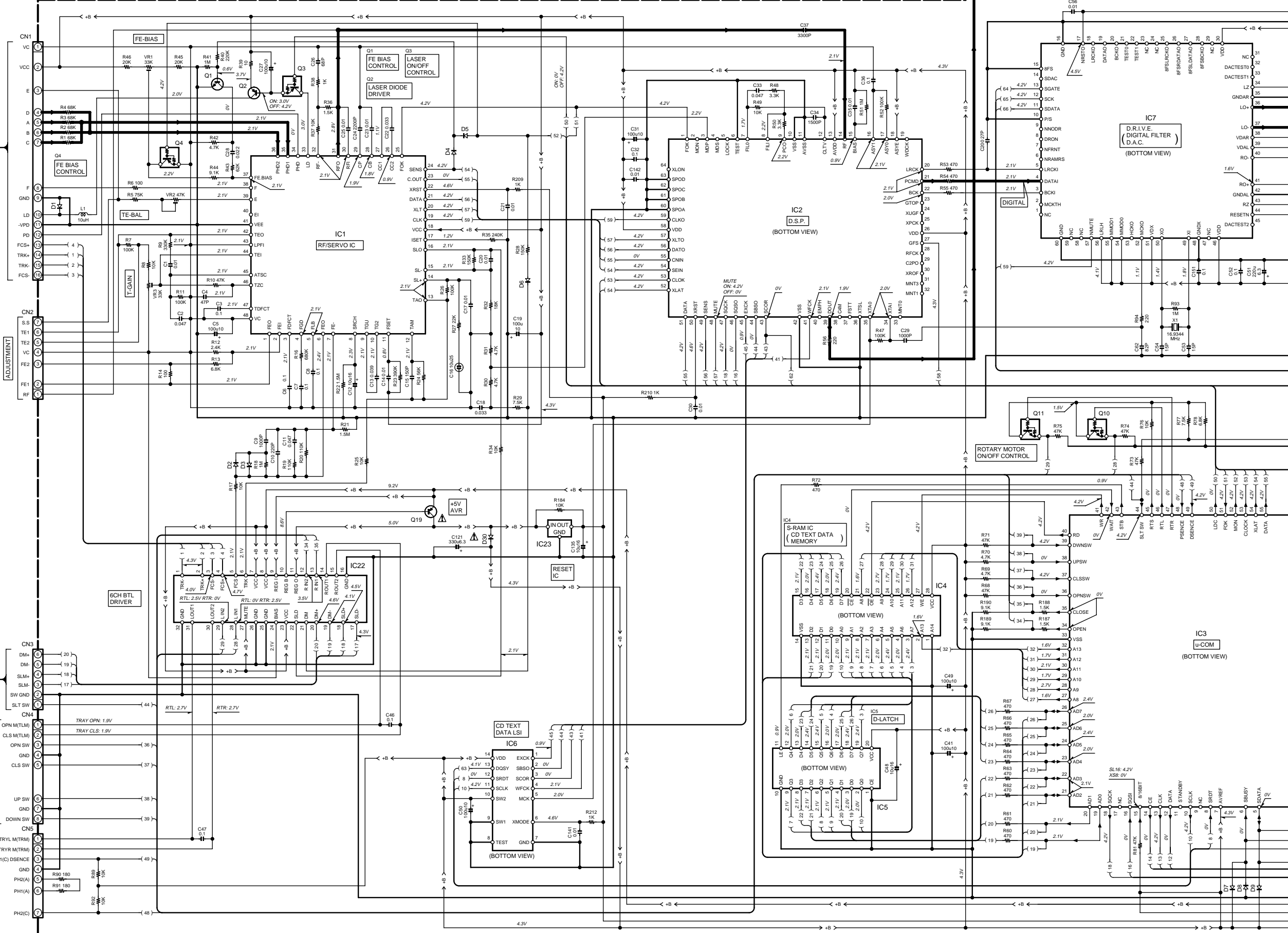
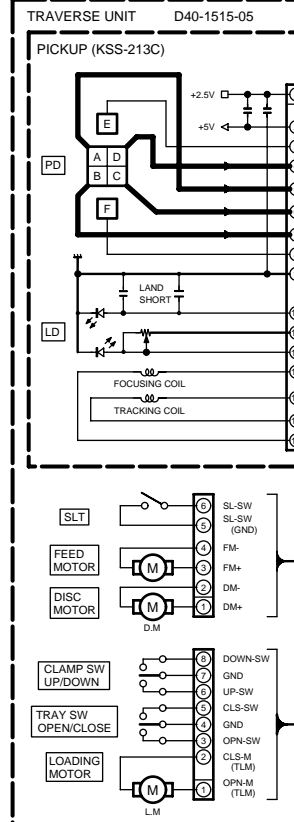

D65 : SIR-33S3T3
PH1 : T95-0145-05
PH2 : RPT-38PT3F

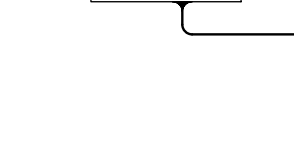
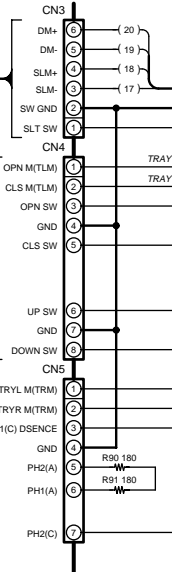
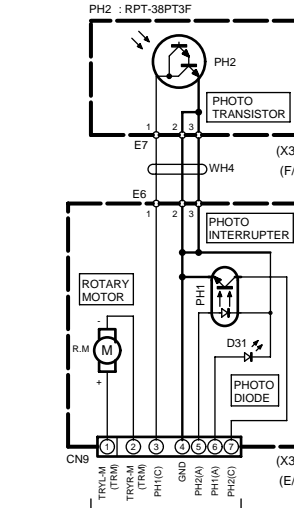

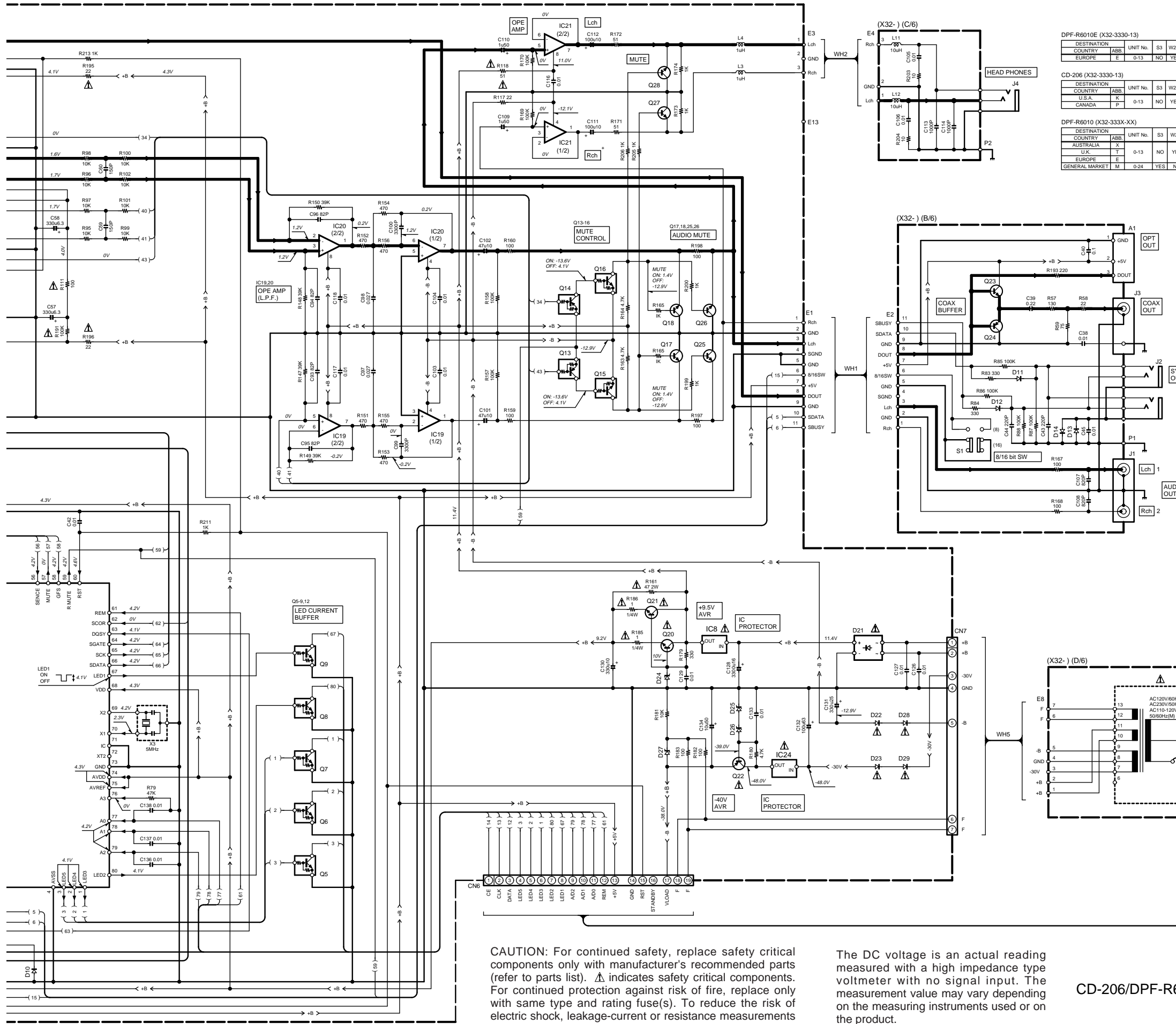

DPF-R6010E (X32-3330-13)				
DESTINATION	ABB.	UNIT No.	S3	W222
COUNTRY				
EUROPE	E	0-13	NO	YES

CD-206 (X32-3330-13)				
DESTINATION	ABB.	UNIT No.	S3	W222
COUNTRY				
U.S.A.	K			
CANADA	P	0-13	NO	YES

DPF-R6010 (X32-333X-XX)				
DESTINATION	ABB.	UNIT No.	S3	W222
COUNTRY				
AUSTRALIA	X			
U.K.	T	0-13	NO	YES
EUROPE	E	0-13	NO	YES
GENERAL MARKET	M	0-24	YES	NO

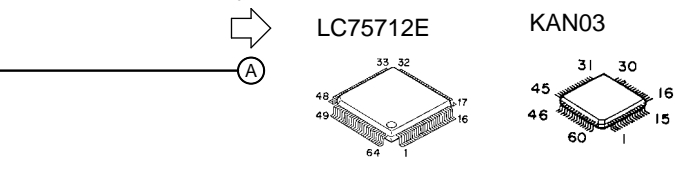
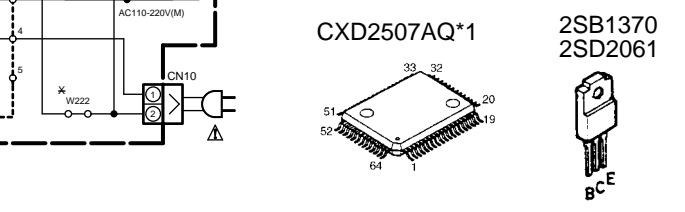
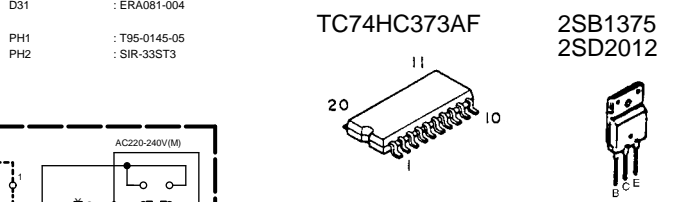
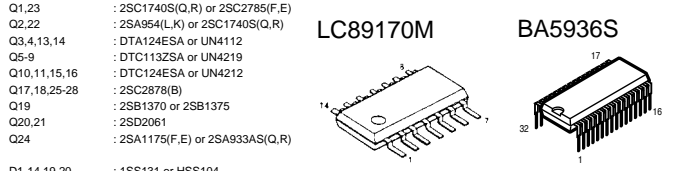
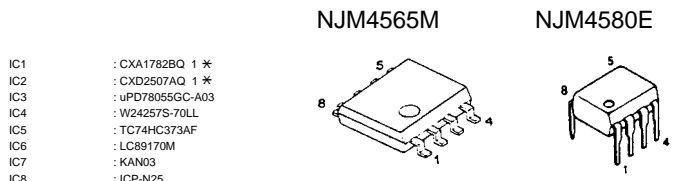
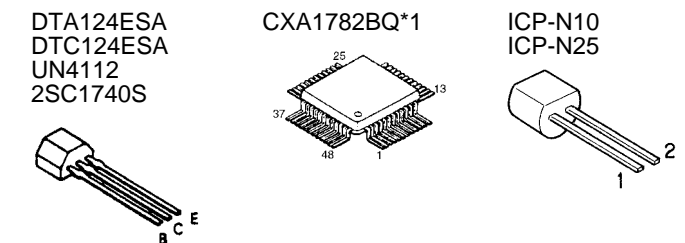
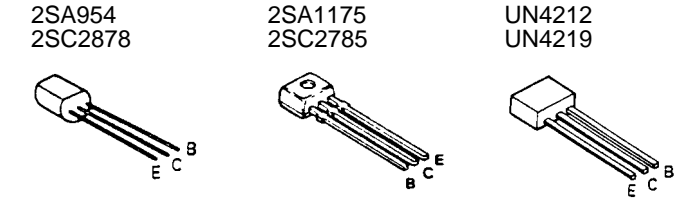

- IC1 : CXA1782BQ 1 *
- IC2 : CXD2507AQ 1 *
- IC3 : uPD78055GC-A03
- IC4 : W24257S-70LL
- IC5 : TC74HC373AF
- IC6 : LC89170M
- IC7 : KAN03
- IC8 : ICP-N25
- IC19,20 : NJM4565M
- IC21 : NJM4580E
- IC22 : BA5936S
- IC23 : PST993D-T
- IC24 : ICP-N10
- Q1,23 : 2SC1740S(Q,R) or 2SC2785(F,E)
- Q2,22 : 2SA954(L,K) or 2SC1740S(Q,R)
- Q3,4,13,14 : DTA124ESA or UN4112
- Q5-9 : DTC1132SA or UN4219
- Q10,11,15,16 : DTC124ESA or UN4212
- Q17,18,25-28 : 2SC2878(B)
- Q19 : 2SB1370 or 2SB1375
- Q20,21 : 2SD2061
- Q24 : 2SA1175(F,E) or 2SA933AS(Q,R)
- D1-14,19,20 : 1SS131 or HSS104
- D21 : D3SBA20F03 or RBV-402LFA
- D22,23,28-30 : S5688B or 1SR139-400
- D24 : UZ-10BS or MTZJ10(B)
- D25,26 : UZ-20BS or MTZJ20(B)
- D27 : UZ-15BSB or MTZJ15(B)
- D31 : ERA081-004
- PH1 : T95-0145-05
- PH2 : SIR-33ST3

CAUTION: For continued safety, replace safety critical components only with manufacturer's recommended parts (refer to parts list). Δ indicates safety critical components. For continued protection against risk of fire, replace only with same type and rating fuse(s). To reduce the risk of electric shock, leakage-current or resistance measurements shall be carried out (exposed parts are acceptably insulated from the supply circuit) before the appliance is returned to the customer.

The DC voltage is an actual reading measured with a high impedance type voltmeter with no signal input. The measurement value may vary depending on the measuring instruments used or on the product.

CD-206/DPF-R6010/DPF-R6010E

Y22-7560-10

CD-206/DPF-R6010/R6010E

KENWOOD

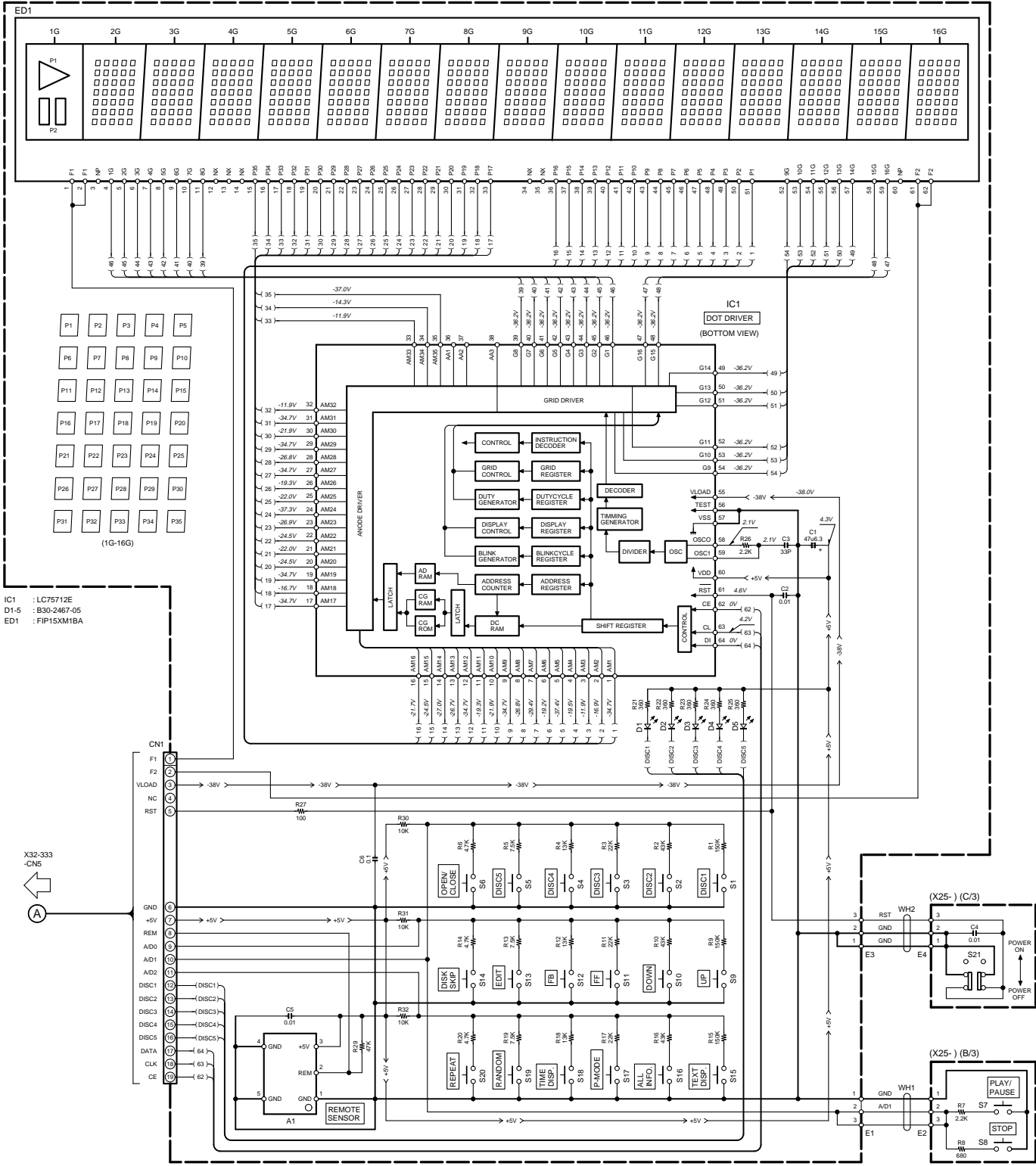

IC1 : LC75712E
D1-5 : B30-2467-05
ED1 : FIP15XM18A

CAUTION: For continued safety, replace safety critical components only with manufacturer's recommended parts (refer to parts list). indicates safety critical components. For continued protection against risk of fire, replace only with same type and rating fuse(s). To reduce the risk of electric shock, leakage-current or resistance measurements shall be carried out (exposed parts are acceptably insulated from the supply circuit) before the appliance is returned to the customer.

The DC voltage is an actual reading measured with a high impedance type voltmeter with no signal input. The measurement value may vary depending on the measuring instruments used or on the product.

CD-206/DPF-R6010/R6010E

Y22-7560-10

KENWOOD

CD-206/DPF-R6010/R6010E

EXPLODED VIEW (MECHANISM)

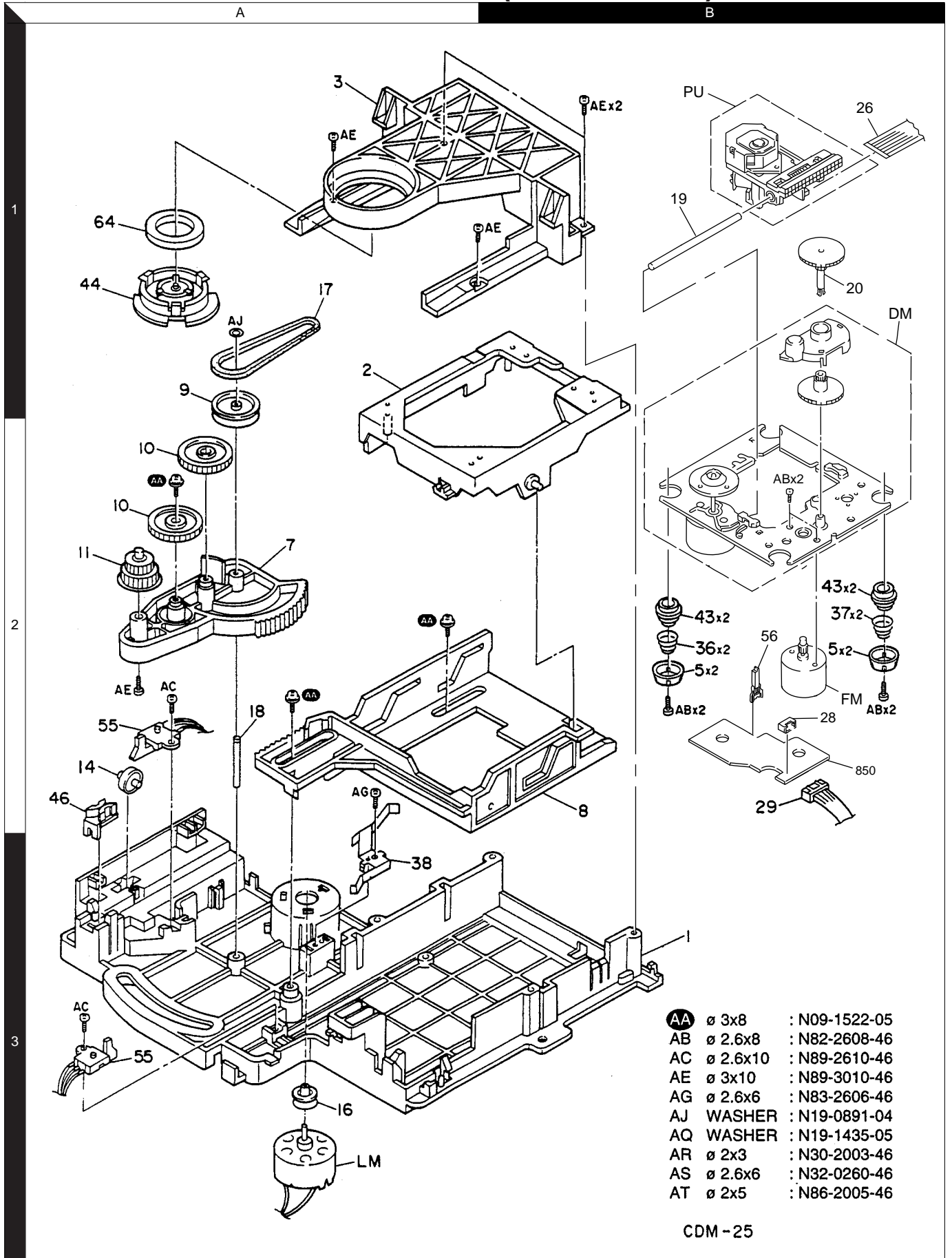

* New Parts
Parts without **Parts No.** are not supplied.
Les articles non mentionnés dans le **Parts No.** ne sont pas fournis.
Teile ohne **Parts No.** werden nicht geliefert.

1

Ref. No	Add-ress	New Parts	Parts No.	Description	Desti-nation	Re-marks
CD-206/DPF-R6010/R6010E						
601	1D		A01-3547-01	METALLIC CABINET		
603	1D	*	A60-1352-21	PANEL	K1P1	
603	1D	*	A60-1462-11	PANEL	E1E2	
603	1D	*	A60-1462-11	PANEL	M1X1T1	
604	1C		A70-1134-05	REMOTE CONTROLLER ASSY		
605	1C		A09-0356-08	BATTERY COVER		
606	2C	*	A29-1004-12	PANEL	K1P1	
606	2C	*	A29-1014-12	PANEL	E1E2	
606	2C	*	A29-1014-12	PANEL	M1X1T1	
610	2D	*	B07-2407-12	ESCUTCHEON	K1P1	
610	2D	*	B07-2418-12	ESCUTCHEON	E1E2	
610	2D	*	B07-2418-12	ESCUTCHEON	M1X1T1	
611	2D	*	B10-2466-03	FRONT GLASS		
-			B46-0096-53	WARRANTY CARD	X1	
-			B46-0197-00	QUESTIONNAIRE CARD	K1	
-			B46-0310-03	WARRANTY CARD	T1E1E2	
-			B46-0328-03	WARRANTY CARD	K1	
-			B46-0336-03	WARRANTY CARD	P1	
-			B58-0945-03	CAUTION CARD	T1	
-			B58-0964-13	CAUTION CARD (UL)	K1	
-			B58-0965-13	CAUTION CARD (T.XtypePL)	X1T1	
-			B58-0966-13	CAUTION CARD (ELMtypePL)	M1E1	
-			B58-0967-03	CAUTION CARD (PtypePL)	P1	
-			B58-1607-03	CAUTION CARD	E2	
Δ	-		B60-3684-00	INSTRUCTION MANUAL(ENGLISH)	K1P1M1	
Δ	-		B60-3684-00	INSTRUCTION MANUAL(ENGLISH)	X1T1E2	
Δ	-		B60-3685-00	INSTRUCTION MANUAL(FRENCH)	P1E1	
Δ	-		B60-3686-00	INSTRUCTION MANUAL(G.D.I)	E1	
Δ	-		B60-3687-00	INSTRUCTION MANUAL(SPANISH)	M1E1	
Δ	-		B60-3688-00	INSTRUCTION MANUAL(TAIWANESE)	M1	
Δ	-		B60-3969-00	INSTRUCTION MANUAL(PH)	E2	
Δ	-		B60-3970-00	INSTRUCTION MANUAL(R)	E2	
Δ	-		B60-3971-00	INSTRUCTION MANUAL(CZ)	E2	
Δ	-		B60-3972-00	INSTRUCTION MANUAL(HG)	E2	
615	1D		D14-0357-04	ROLLER		
Δ	620	1C	E03-0115-05	AC PLUG ADAPTER	M1	
Δ	621	1C	E30-0505-05	AUDIO CORD		
Δ	622	1E	E30-2592-15	AC POWER CORD	M1E1E2	
Δ	622	1E	E30-2650-05	AC POWER CORD	K1P1	
Δ	622	1E	E30-2717-05	AC POWER CORD	X1	
Δ	622	1E	E30-2721-05	AC POWER CORD	T1	
623	1C		E30-2733-05	CORD WITH PLUG		
624	2E		E35-0400-05	WIRING HARNESS(FLAT CABLE)19P		
626	2D		G10-0444-04	NON-WOVEN FABRIC		
-		*	H10-7466-02	POLYSTYRENE FOAMED FIXTURE	K1P1M1	
-		*	H10-7466-02	POLYSTYRENE FOAMED FIXTURE	X1E1E2	
-		*	H10-7467-12	POLYSTYRENE FOAMED FIXTURE	K1P1M1	
-		*	H10-7467-12	POLYSTYRENE FOAMED FIXTURE	X1E1E2	
-		*	H10-7468-02	POLYSTYRENE FOAMED FIXTURE	T1	
-			H10-7469-02	POLYSTYRENE FOAMED FIXTURE	T1	
-			H12-2210-04	PACKING FIXTURE		

L : Scandinavia K : USA P : Canada R : Mexico C : China I : Malaysia
Y : PX(Far East, Hawaii) T : Europe E : Europe G : Germany V : China (Shanghai)
X : Australia Q : Russia H : Korea M : Other Areas

Δ indicates safety critical components.

* New Parts
Parts without **Parts No.** are not supplied.
Les articles non mentionnés dans le **Parts No.** ne sont pas fournis.
Teile ohne **Parts No.** werden nicht geliefert.

2

Ref. No	Add-ress	New Parts	Parts No.	Description	Desti-nation	Re-marks
-			H13-0152-14	CARTON BOARD	X1	
-			H13-0163-04	CARTON BOARD	T1	
-			H20-0568-04	PROTECTION COVER	M1	
-			H21-0303-04	PROTECTION SHEET		
-			H25-0232-04	PROTECTION BAG (235X350X0.03)	K1P1M1	
-			H25-0232-04	PROTECTION BAG (235X350X0.03)	X1E1E2	
-			H25-0651-04	PROTECTION BAG (0232 PRINT)	T1	
-			H25-0661-04	PROTECTION BAG	K1P1X1	
-			H25-0661-04	PROTECTION BAG	T1E1E2	
-			H50-2784-04	ITEM CARTON CASE	K1P1	
-		*	H50-2785-04	ITEM CARTON CASE	T1	
-		*	H50-2786-04	ITEM CARTON CASE	X1E1	
-		*	H50-2845-04	ITEM CARTON CASE	M1	
-		*	H50-3071-04	ITEM CARTON CASE	E2	
630	2E		J02-1168-03	FOOT	E1E2	
630	2E		J02-1168-03	FOOT	M1X1T1	
630	2E		J02-1407-03	FOOT (D=46,H=14.5,T)	KP1	
631	2D		J21-3326-05	JACK MOUNTING HARDWARE		
Δ	633	1E	J42-0083-05	POWER CORD BUSHING		
634	1C		J90-0811-04	GUIDE		
-			J61-0307-05	WIRE BAND		
640	1C		K27-2178-04	KNOB (BUTTON) POWER	E1E2	
640	1C		K27-2178-04	KNOB (BUTTON) POWER	M1X1T1	
640	1C	*	K27-2273-04	KNOB (BUTTON) POWER	K1P1	
641	1D	*	K29-6938-04	KNOB ASSY	K1P1	
641	1D	*	K29-7332-04	KNOB ASSY	E1E2	
641	1D	*	K29-7332-04	KNOB ASSY	M1X1T1	
Δ	645	2E	L07-2304-05	POWER TRANSFORMER	K1P1	
Δ	645	2E	L07-2306-05	POWER TRANSFORMER	M1	
Δ	645	2E	L07-2411-05	POWER TRANSFORMER	E2	
Δ	645	2E	L07-2411-05	POWER TRANSFORMER	X1T1E1	
DISPLAY UNIT (X25-5900-10)						
D1 -5			B30-2467-05	LED		
C1			C90-3212-05	ELECTRO 47UF 6.3WV		
C2			CK45FF1H103ZMU	CERAMIC 0.010UF Z		
C3			CC45FSL1H330JM	CERAMIC 33PF J		
C4 .5			CK45FF1H103ZMU	CERAMIC 0.010UF Z		
C6			CF92FV1H104J	MF-C 0.10UF J		
CN1			E40-4944-05	FLAT CABLE CONNECTOR(19P)		
-			J19-5789-04	HOLDER		
S1 -5			S70-0802-05	TACT SWITCH		
S6 -20			S70-0031-05	TACT SWITCH		
S21			S40-2351-05	PUSH SWITCH		
ED1			FIP15XM1BA	INDICATOR TUBE		
IC1			LC75712E	MOS-IC		
A1			W02-2537-05	ELECTRIC CIRCUIT MODULE		
CD PLAYER UNIT (X32-3330-XX)						
C1			CK73FB1H103K	CHIP C 0.010UF K		
C2			CK73FB1H473K	CHIP C 0.047UF K		
C3			CK73FB1E104K	CHIP C 0.10UF K		

L : Scandinavia K : USA P : Canada R : Mexico C : China I : Malaysia
Y : PX(Far East, Hawaii) T : Europe E : Europe G : Germany V : China (Shanghai)
X : Australia Q : Russia H : Korea M : Other Areas

Δ indicates safety critical components.

* New Parts
Parts without **Parts No.** are not supplied.
Les articles non mentionnés dans le **Parts No.** ne sont pas fournis.
Teile ohne **Parts No.** werden nicht geliefert.

3

Ref. No	Add-ress	New Parts	Parts No.	Description	Desti-nation	Re-marks
C4			CC73FSL1H470J	CHIP C 47PF J		
C5			CE04KW1A101M	ELECTRO 100UF 10WV		
C6 -8			CK73FB1E104K	CHIP C 0.10UF K		
C9			CK73FB1H102K	CHIP C 1000PF K		
C10			CC73FSL1H221J	CHIP C 220PF J		
C11			CK73FB1H473K	CHIP C 0.047UF K		
C12			CE04KW1C100M	ELECTRO 10UF 16WV		
C13			CK73FB1H393K	CHIP C 0.039UF K		
C14			CK73FB1H103K	CHIP C 0.010UF K		
C15			CC73FSL1H151J	CHIP C 150PF J		
C16			CE04HW1E100M	NP-ELEC 10UF 25WV		
C17			CK73FB1H103K	CHIP C 0.010UF K		
C18			CK73FB1H333K	CHIP C 0.033UF K		
C19			CE04KW1A101M	ELECTRO 100UF 10WV		
C20 ,21			CK73FB1H103K	CHIP C 0.010UF K		
C22			CK73FB1H333K	CHIP C 0.033UF K		
C23			CK73FB1H103K	CHIP C 0.010UF K		
C24			CK73FB1H222K	CHIP C 2200PF K		
C25			CK73FB1H103K	CHIP C 0.010UF K		
C26			CC73FSL1H270J	CHIP C 27PF J		
C27			C90-3222-05	ELECTRO 100UF 10WV		
C28			CK73FB1H223K	CHIP C 0.022UF K		
C29			CK73FB1H102K	CHIP C 1000PF K		
C30			CK73FB1H103K	CHIP C 0.010UF K		
C31			CE04KW1A101M	ELECTRO 100UF 10WV		
C32			CK73FB1E104K	CHIP C 0.10UF K		
C33			CK73FB1H473K	CHIP C 0.047UF K		
C34			CK73FB1H152K	CHIP C 1500PF K		
C35			CK73FB1H103K	CHIP C 0.010UF K		
C36			CK73FB1E104K	CHIP C 0.10UF K		
C37			CK73FB1H332K	CHIP C 3300PF K		
C38			CK73FB1H103K	CHIP C 0.010UF K		
C39			CK73FB1C224K	CHIP C 0.22UF K		
C40			CK73FB1E104K	CHIP C 0.10UF K		
C41			CE04KW1A101M	ELECTRO 100UF 10WV		
C42			CK73FB1H103K	CHIP C 0.010UF K		
C43 ,44			CC73FSL1H221J	CHIP C 220PF J		
C45			CK73FB1H103K	CHIP C 0.010UF K		
C46 ,47			CK73FB1E104K	CHIP C 0.10UF K		
C48			CE04KW1C100M	ELECTRO 10UF 16WV		
C49 ,50			CE04KW1A101M	ELECTRO 100UF 10WV		
C51			C90-3215-05	ELECTRO 220UF 6.3WV		
C52			CK73FB1E104K	CHIP C 0.10UF K		
C53 ,54			CC73FSL1H150J	CHIP C 15PF J		
C56			CK73FB1H103K	CHIP C 0.010UF K		
C57 ,58			C90-3216-05	ELECTRO 330UF 6.3WV		
C59 ,60			CC73FSL1H151J	CHIP C 150PF J		
C62			CC73FSL1H820J	CHIP C 82PF J		
C93 -96			CC45FSL1H820JM	CERAMIC 82PF J		
C97 ,98			CQ93FMG1H273J	MYLAR 0.027UF J		
C99 ,100			CQ93FMG1H332J	MYLAR 3300PF J		
C101,102			CE04KW1A470M	ELECTRO 47UF 10WV		
C103-106			CK73FB1H103K	CHIP C 0.010UF K		
C107,108			CC73FSL1H821J	CHIP C 820PF J		
C109,110			CE04KW1H010M	ELECTRO 1.0UF 50WV		

L : Scandinavia K : USA P : Canada R : Mexico C : China I : Malaysia
Y : PX(Far East, Hawaii) T : Europe E : Europe G : Germany V : China (Shanghai)
Y : AAFES(Europe) X : Australia Q : Russia H : Korea M : Other Areas

△ indicates safety critical components.

* New Parts
Parts without **Parts No.** are not supplied.
Les articles non mentionnés dans le **Parts No.** ne sont pas fournis.
Teile ohne **Parts No.** werden nicht geliefert.

4

Ref. No	Add-ress	New Parts	Parts No.	Description	Desti-nation	Re-marks
C111,112			CE04KW1A101M	ELECTRO 100UF 10WV		
C113,114			CK73FB1H102K	CHIP C 1000PF K		
C116-118			CK73FB1H103K	CHIP C 0.010UF K		
C121			CE04KW0J331M	ELECTRO 330UF 6.3WV		
C126,127			CK45FF1H103ZMU	CERAMIC 0.010UF Z		
C128			CE04KW1C332M	ELECTRO 3300UF 16WV		
C129			CK73FB1H103K	CHIP C 0.010UF K		
C130			CE04KW1A331M	ELECTRO 330UF 10WV		
C131			CE04DW1E331M	ELECTRO 330UF 25WV		
C132			CE04DW1J101M	ELECTRO 100UF 63WV		
C133			CK73FB1H103K	CHIP C 0.010UF K		
C134			CE04KW1H100M	ELECTRO 10UF 50WV		
C135			CE04KW1C100M	ELECTRO 10UF 16WV		
C136-138			CK73FB1H103K	CHIP C 0.010UF K		
C141,142			CK73FB1H103K	CHIP C 0.010UF K		
C151			CK73FB1E104K	CHIP C 0.10UF K		
C200			CC45FSL1H270JM	CERAMIC 27PF J		
CN1			E40-8037-05	FLAT CABLE CONNECTOR		
CN2			E40-0711-05	PIN ASSY		
CN3			E40-3250-05	PIN ASSY		
CN4			E40-3252-05	PIN ASSY		
CN5			E40-4187-05	FLAT CABLE CONNECTOR		
CN6			E40-4906-05	FLAT CABLE CONNECTOR		
CN7			E40-4297-05	FLAT CABLE CONNECTOR		
CN9			E40-4187-05	FLAT CABLE CONNECTOR		
CN10			E40-4245-05	PIN ASSY		
J1			E63-1009-05	PHONO JACK		
J2			E11-0293-05	MINIATURE PHONE JACK(2P)		
J3			E63-0199-05	PHONO JACK		
J4			E11-0127-05	PHONE JACK (3P)		
E9 -11			J11-0808-05	WIRE CLAMPER		
E12			J11-0809-05	WIRE CLAMPER		
L1			L40-1001-17	SMALL FIXED INDUCTOR(10UH,K)		
L3 ,4			L40-1091-17	SMALL FIXED INDUCTOR		
L11 ,12			L40-1001-17	SMALL FIXED INDUCTOR(10UH,K)		
X1			L77-2217-05	CRYSTAL RESONATOR(16.9344MHZ)		
X3			L78-0284-05	RESONATOR (5MHZ)		
R1 -4			RK73FB2A683J	CHIP R 68K J 1/10W		
R5			RK73FB2A753J	CHIP R 75K J 1/10W		
R6			RK73FB2A104J	CHIP R 100K J 1/10W		
R7			RK73FB2A101J	CHIP R 100 J 1/10W		
R8			RK73FB2A472J	CHIP R 4.7K J 1/10W		
R9			RK73FB2A334J	CHIP R 330K J 1/10W		
R10			RK73FB2A473J	CHIP R 47K J 1/10W		
R11			RK73FB2A334J	CHIP R 330K J 1/10W		
R12			RK73FB2A682J	CHIP R 6.8K J 1/10W		
R13			RK73FB2A362J	CHIP R 3.6K J 1/10W		
R14			RK73FB2A101J	CHIP R 100 J 1/10W		
R16			RK73FB2A684J	CHIP R 680K J 1/10W		
R17			RK73FB2A103J	CHIP R 10K J 1/10W		
R18			RK73FB2A105J	CHIP R 1.0M J 1/10W		
R19			RK73FB2A184J	CHIP R 180K J 1/10W		
R20			RK73FB2A823J	CHIP R 82K J 1/10W		

L : Scandinavia K : USA P : Canada R : Mexico C : China I : Malaysia
Y : PX(Far East, Hawaii) T : Europe E : Europe G : Germany V : China (Shanghai)
Y : AAFES(Europe) X : Australia Q : Russia H : Korea M : Other Areas

△ indicates safety critical components.

PARTS LIST

CD-206/DPF-R6010/R6010E

* New Parts
 Parts without **Parts No.** are not supplied.
 Les articles non mentionnés dans le **Parts No.** ne sont pas fournis.
 Teile ohne **Parts No.** werden nicht geliefert.

5

Ref. No	Add- ress	New Parts	Parts No.	Description	Desti- nation	Re- marks
R21 ,22			RK73FB2A155J	CHIP R 1.5M J 1/10W		
R23			RK73FB2A154J	CHIP R 510K J 1/10W		
R24			RK73FB2A823J	CHIP R 82K J 1/10W		
R25			RK73FB2A103J	CHIP R 10K J 1/10W		
R26			RK73FB2A104J	CHIP R 100K J 1/10W		
R27			RK73FB2A223J	CHIP R 22K J 1/10W		
R28			RK73FB2A154J	CHIP R 150K J 1/10W		
R29			RK73FB2A752J	CHIP R 7.5K J 1/10W		
R30 ,31			RK73FB2A472J	CHIP R 4.7K J 1/10W		
R32			RK73FB2A183J	CHIP R 18K J 1/10W		
R33			RK73FB2A114J	CHIP R 110K J 1/10W		
R34			RK73FB2A103J	CHIP R 10K J 1/10W		
R35			RK73FB2A244J	CHIP R 240K J 1/10W		
R36			RK73FB2A392J	CHIP R 3.9K J 1/10W		
R37			RK73FB2A243J	CHIP R 24K J 1/10W		
R38			RK73FB2A332J	CHIP R 3.3K J 1/10W		
R39			RK73FB2A100J	CHIP R 10 J 1/10W		
R40			RK73FB2A224J	CHIP R 220K J 1/10W		
R41			RK73FB2A105J	CHIP R 1.0M J 1/10W		
R42			RK73FB2A472J	CHIP R 4.7K J 1/10W		
R43			RK73FB2A623J	CHIP R 62K J 1/10W		
R44			RK73FB2A912J	CHIP R 9.1K J 1/10W		
R45 ,46			RK73FB2A203J	CHIP R 20K J 1/10W		
R47			RK73FB2A104J	CHIP R 100K J 1/10W		
R48			RK73FB2A332J	CHIP R 3.3K J 1/10W		
R49			RK73FB2A103J	CHIP R 10K J 1/10W		
R50			RK73FB2A332J	CHIP R 3.3K J 1/10W		
R51			RK73FB2A105J	CHIP R 1.0M J 1/10W		
R52			RK73FB2A104J	CHIP R 100K J 1/10W		
R53 -55			RK73FB2A471J	CHIP R 470 J 1/10W		
R56			RK73FB2A221J	CHIP R 220 J 1/10W		
R57			RK73FB2A131J	CHIP R 130 J 1/10W		
R58			RK73FB2A220J	CHIP R 22 J 1/10W		
R59			RK73FB2A750J	CHIP R 75 J 1/10W		
R60 -67			RK73FB2A471J	CHIP R 470 J 1/10W		
R68			RK73FB2A473J	CHIP R 47K J 1/10W		
R69 ,70			RK73FB2A472J	CHIP R 4.7K J 1/10W		
R71			RK73FB2A473J	CHIP R 47K J 1/10W		
R72			RK73FB2A471J	CHIP R 470 J 1/10W		
R73 -75			RK73FB2A473J	CHIP R 47K J 1/10W		
R76			RK73FB2A103J	CHIP R 10K J 1/10W		
R77			RK73FB2A752J	CHIP R 7.5K J 1/10W		
R78			RK73FB2A682J	CHIP R 6.8K J 1/10W		
R79			RK73FB2A473J	CHIP R 47K J 1/10W		
R81			RK73FB2A473J	CHIP R 47K J 1/10W		
R83 ,84			RK73FB2A331J	CHIP R 330 J 1/10W		
R85 -88			RK73FB2A104J	CHIP R 100K J 1/10W		
R89			RK73FB2A103J	CHIP R 10K J 1/10W		
R90 ,91			RK73FB2A181J	CHIP R 180 J 1/10W		
R92			RK73FB2A103J	CHIP R 10K J 1/10W		
R93			RK73FB2A105J	CHIP R 1.0M J 1/10W		
R94			RK73FB2A221J	CHIP R 220 J 1/10W		
R95 -102			RK73FB2A103J	CHIP R 10K J 1/10W		
R111			RK73FB2A101J	CHIP R 100 J 1/10W		
R117			RK73FB2A220J	CHIP R 22 J 1/10W		

L : Scandinavia K : USA P : Canada R : Mexico C : China I : Malaysia
 Y : PX(Far East, Hawaii) T : Europe E : Europe G : Germany V : China (Shanghai)
 Y : AAFES(Europe) X : Australia Q : Russia H : Korea M : Other Areas

Δ indicates safety critical components.

* New Parts
 Parts without **Parts No.** are not supplied.
 Les articles non mentionnés dans le **Parts No.** ne sont pas fournis.
 Teile ohne **Parts No.** werden nicht geliefert.

5

Ref. No	Add- ress	New Parts	Parts No.	Description	Desti- nation	Re- marks
Δ R118			RK73FB2A510J	CHIP R 51 J 1/10W		
R147-150			RK73FB2A393J	CHIP R 39K J 1/10W		
R151-156			RK73FB2A471J	CHIP R 470 J 1/10W		
R157,158			RK73FB2A104J	CHIP R 100K J 1/10W		
R159,160			RK73FB2A101J	CHIP R 100 J 1/10W		
Δ R161			RS14KB3D470J	FL-PROOF RS 47 J 2W		
R163,164			RK73FB2A472J	CHIP R 4.7K J 1/10W		
R165,166			RK73FB2A102J	CHIP R 1.0K J 1/10W		
R167,168			RK73FB2A101J	CHIP R 100 J 1/10W		
R169,170			RK73FB2A104J	CHIP R 100K J 1/10W		
R171,172			RK73FB2A510J	CHIP R 51 J 1/10W		
R173,174			RK73FB2A102J	CHIP R 1.0K J 1/10W		
R179			RK73FB2A331J	CHIP R 330 J 1/10W		
R180			RK73FB2A472J	CHIP R 4.7K J 1/10W		
R181			RK73FB2A103J	CHIP R 10K J 1/10W		
R182,183			RK73FB2A101J	CHIP R 100 J 1/10W		
R184			RK73FB2A103J	CHIP R 10K J 1/10W		
Δ R185,186			RD14NB2E1R0J	RD 1 J 1/4W		
R187,188			RK73FB2A152J	CHIP R 1.5K J 1/10W		
R189,190			RK73FB2A912J	CHIP R 9.1K J 1/10W		
Δ R191			RK73FB2A101J	CHIP R 100 J 1/10W		
R193			RK73FB2A221J	CHIP R 220 J 1/10W		
Δ R195,196			RK73FB2A220J	CHIP R 22 J 1/10W		
R197,198			RK73FB2A101J	CHIP R 100 J 1/10W		
R199,200			RK73FB2A102J	CHIP R 1.0K J 1/10W		
R203,204			RK73FB2A100J	CHIP R 10 J 1/10W		
R205,206			RK73FB2A102J	CHIP R 1.0K J 1/10W		
R209-213			RK73FB2A102J	CHIP R 1.0K J 1/10W		
VR1			R12-3687-05	TRIMMING POT.(33K)		
VR2			R12-3688-05	TRIMMING POT.(47K)		
VR3			R12-3687-05	TRIMMING POT.(33K)		
S1			S31-2132-05	SLIDE SWITCH		
Δ S3			S31-2131-05	SLIDE SWITCH (POWER TYPE)	M1	
PH1			T95-0145-05	OPTO ISOLATOR		
D1 -14			HSS104A	DIODE		
D1 -14			1SS131	DIODE		
Δ D21			D3SBA20F03	DIODE		
Δ D21			RBV-402LFA	DIODE		
Δ D22 ,23			S5688B	DIODE		
Δ D22 ,23			1SR139-400	DIODE		
D24			MTZJ10(B)	ZENER DIODE		
D24			UZ-10BSB	ZENER DIODE		
D25 ,26			MTZJ20(B)	ZENER DIODE		
D25 ,26			UZ-20BS	ZENER DIODE		
D27			MTZJ15(B)	ZENER DIODE		
D27			UZ-15BSB	ZENER DIODE		
Δ D28 -30			S5688B	DIODE		
Δ D28 -30			1SR139-400	DIODE		
D31			SIR-33ST3	INFRARED LED		
IC1			CXA1782BQ*1	ANALOGUE IC		
IC2			CXD2507AQ*1	MOS-IC		
IC3			UPD78055GC-A03	MI-COM IC		
IC4			W24257S-70LL	MEMORY IC		

L : Scandinavia K : USA P : Canada R : Mexico C : China I : Malaysia
 Y : PX(Far East, Hawaii) T : Europe E : Europe G : Germany V : China (Shanghai)
 Y : AAFES(Europe) X : Australia Q : Russia H : Korea M : Other Areas

Δ indicates safety critical components.

PARTS LIST

* New Parts
 Parts without **Parts No.** are not supplied.
 Les articles non mentionnés dans le **Parts No.** ne sont pas fournis.
 Teile ohne **Parts No.** werden nicht geliefert.

7

Ref. No	Add-ress	New Parts	Parts No.	Description	Desti-nation	Re-marks
IC5			TC74HC373AF	IC(8 bit LATCH)		
IC6			LC89170M	MOS-IC		
IC7			KAN03	CUSTOM IC		
IC8			ICP-N25	ANALOGUE IC		
IC19,20			NJM4565M	IC(OP AMP X2)		
IC21			NJM4580E	ANALOGUE IC		
IC22			BA5936S	ANALOGUE IC		
IC23			PST993D-T	ANALOGUE IC		
IC24			ICP-N10	ANALOGUE IC		
PH2			RPT-38PT3F	PHOTO TRANSISTOR		
Q1			2SC1740S(Q,R)	TRANSISTOR		
Q1			2SC2785(F,E)	TRANSISTOR		
Q2			2SA954(L,K)	TRANSISTOR		
Q3 ,4			DTA124ESA	DIGITAL TRANSISTOR		
Q3 ,4			UN4112	DIGITAL TRANSISTOR		
Q5 -9			DTC113ZSA	DIGITAL TRANSISTOR		
Q5 -9			UN4219	DIGITAL TRANSISTOR		
Q10 ,11			DTC124ESA	DIGITAL TRANSISTOR		
Q10 ,11			UN4212	DIGITAL TRANSISTOR		
Q13 ,14			DTA124ESA	DIGITAL TRANSISTOR		
Q13 ,14			UN4112	DIGITAL TRANSISTOR		
Q15 ,16			DTC124ESA	DIGITAL TRANSISTOR		
Q15 ,16			UN4212	DIGITAL TRANSISTOR		
Q17 ,18			2SC2878(B)	TRANSISTOR		
Q19			2SB1370	TRANSISTOR		
Q19			2SB1375	TRANSISTOR		
Q20 ,21			2SD2012	TRANSISTOR		
Q20 ,21			2SD2061	TRANSISTOR		
Q22			2SA954(L,K)	TRANSISTOR		
Q23			2SC1740S(Q,R)	TRANSISTOR		
Q23			2SC2785(F,E)	TRANSISTOR		
Q24			2SA1175(F,E)	TRANSISTOR		
Q24			2SA933AS(Q,R)	TRANSISTOR		
Q25 -28			2SC2878(B)	TRANSISTOR		
A1			W02-1114-05	OSCILLATING MODULE		

CD MECHANISM (X92-1930-10/X92-1960-91)

1	3B		A10-3106-31	CHASSIS		
2	1A		A11-1048-12	SUB CHASSIS		
3	1A		A11-1140-02	SUB CHASSIS		
5	2B		B09-0250-04	CAP		
7	2A		D10-3439-13	ARM		
9	1A		D13-1829-04	GEAR		
10	2A		D13-1578-04	GEAR		
11	2A		D13-1579-04	GEAR		
12	2D		D13-1682-04	WORM		
13	2C		D13-1581-04	GEAR		
14	2A,2C		D14-0357-04	ROLLER		
16	3A		D15-0359-04	PULLEY		
17	1A		D16-0355-03	BELT		
18	2A		D21-1763-14	SHAFT		
19	2B		D10-3606-08	ROD		
20	1B		D10-1720-08	GEAR		
25	2D		E35-0747-25	FLAT CABLE		

L : Scandinavia K : USA P : Canada R : Mexico C : China I : Malaysia
 Y : PX(Far East, Hawaii) T : Europe E : Europe G : Germany V : China (Shanghai)
 Y : AAFES(Europe) X : Australia Q : Russia H : Korea M : Other Areas

△ indicates safety critical components.

* New Parts
 Parts without **Parts No.** are not supplied.
 Les articles non mentionnés dans le **Parts No.** ne sont pas fournis.
 Teile ohne **Parts No.** werden nicht geliefert.

8

Ref. No	Add-ress	New Parts	Parts No.	Description	Desti-nation	Re-marks
26	1B		E35-1317-05	FLAT CABLE		
28	2B		E40-3264-05	PIN ASSY		
29	2B		E35-1669-05	WIRING HARNESS		
35	2C		G01-3630-14	COMPRESSION SPRING		
36	2B		G01-3753-04	COMPRESSION SPRING		
37	2B		G01-3754-04	COMPRESSION SPRING		
38	3A		G02-1049-04	FLAT SPRING		
39	2D		G09-0634-04	WIRE SPRING		
41	2C		G02-1065-04	FLAT SPRING		
43	2B		J02-1121-04	INSULATOR		
44	1A		J11-0830-13	CLAMPER		
45	2D		J19-3634-04	HOLDER		
46	2A		J90-0811-04	GUIDE		
47	2E		J90-0810-32	GUIDE		
48	2C		J99-0575-01	TRAY		
49	2C		J99-0547-01	TRAY		
55	2A,3A		S33-2061-05	LEVER SWITCH		
56	2B		S74-0038-08	LEAF SWITCH		
64	1A		T99-0544-15	MAGNET		
DM	1B		A11-1082-18	DISC MOTOR ASSY		
FM	2B		T42-0817-08	MOTOR ASSY		
LM	3A		T42-0524-05	DC MOTOR		
PU	1B		T25-0055-08	OPTICAL PICKUP HEAD		
RM	2D		T42-0670-15	DC MOTOR		

L : Scandinavia K : USA P : Canada R : Mexico C : China I : Malaysia
 Y : PX(Far East, Hawaii) T : Europe E : Europe G : Germany V : China (Shanghai)
 Y : AAFES(Europe) X : Australia Q : Russia H : Korea M : Other Areas

△ indicates safety critical components.

HOW TO READ THE PARTS LIST

ABBREVIATION OF MODEL AND MASS PRODUCTION'S DESTINATIONS

MODEL	ABB.	Australia	Canada	China	England	Europe	Germany	Korea	Malaysia
CD-206	-	-	P1	-	-	-	-	-	-
DPF-R6010	-	X1	-	-	T1	E1	-	-	-
DPF-R6010E	-	-	-	-	-	E2	-	-	-
MODEL	ABB.	Mexico	PX/AAFES	Russia	Scandinavia	Shanghai	USA	Other area	
CD-206	-	-	-	-	-	-	K1	-	-
DPF-R6010	-	-	-	-	-	-	-	M1	-
DPF-R6010E	-	-	-	-	-	-	-	-	-

CD-206 is the model name to sell in North America.
 DPF-R6010 and DPF-R6010E are the models name to sell except above country.

PARTS LIST

CD-206/DPF-R6010/R6010E

CD-206/DPF-R6010/R6010E

SPECIFICATIONS

CD-206/DPF-R6010

[Format]

System Compact disc digital audio system
Laser Semiconductor laser

[D/A Convertors]

D/A Conversion 1 Bit (D.R.I.V.E.)
Oversampling 8 fs (352.8 kHz)

[Audio]

Frequency response 4 Hz – 20 kHz, ± 0.5 dB
Signal to noise ratio More than 100 dB
Dynamic range More than 95 dB
Total harmonic distortion + noise
..... Less than 0.005% (at 1 kHz)
Wow & flutter Unmeasurable Limit
Output level/impedance
Variable (Max.) 2 V/0.3 k Ω
Digital output
Coaxial 0.5 V p-p / 75 Ω
Optical -15 dBm – -21 dBm
(Wave length 660 nm)
Headphone output (Max.) 20 mW (32 Ω)

[General]

Power consumption 14 W
Dimensions W: 440 mm (17-5/16")
H: 125 mm (4-15/16")
D: 397 mm (15-5/8")
Weight (Net) 5.0 kg (11.0 lb)



1. KENWOOD follows a policy of continuous advancements in development. For this reason specifications may be changed without notice.
2. The full performance may not be exhibited in an extremely cold location (under a water-freezing temperature).

KENWOOD CORPORATION

14-6, Dogenzaka 1-chome, Shibuya-ku, Tokyo, 150 Japan

KENWOOD SERVICE CORPORATION

P.O BOX 22745, 2201 East Dominguez St., Long Beach, CA 90801-5745, U.S.A.

KENWOOD ELECTRONICS CANADA INC.

6070 Kestrel Road, Mississauga, Ontario, Canada L5T 1S8

KENWOOD ELECTRONICS LATIN AMERICA S.A.

P.O BOX 55-2791, Piso 6 plaza Chase, Cl. 47 y Aquilino de la Guardia Panama, Republic de Panama

KENWOOD ELECTRONICS BRASIL LTDA.

Av Indianópolis, 628, 04062-001 Planalto Paullsta São Paulo-SP-Brasil

KENWOOD ELECTRONICS U.K. LIMITED

KENWOOD House, Dwight Road, Watford, Herts., WD1 8EB., United Kingdom

KENWOOD ELECTRONICS BELGUM N.V.

Meachelsesteenweg 418, B-1930 Zaventem, Belgium

KENWOOD ELECTRONICS DEUTSCHLAND GMBH

Rembrücker Str. 15, 63150 Heusenstamm, Germany

KENWOOD ELECTRONICS FRANCE S.A.

13 Boulevard Ney, 75018 Paris, France

KENWOOD ELECTRONICS ITALIA S.p.A.

Via G. Sirtori, 7/9 20129, Milano, Italy

KENWOOD IBÉRICA S.A.

Bolivia, 239-08020 Barcelona, Spain

KENWOOD ELECTRONICS AUSTRALIA PTY. LTD.

(A.C.N. 001499 074)

P.O Box 504, 8 Figtree Drive, Australia Centre, Homebush, N.S.W. 2140, Australia

KENWOOD & LEE ELECTRONICS, LTD.

Unit 3712-3724, Level 37, Tower 1, Metroplaza, 223 Hing Fong Road, Kwai Fong N.T., Hong Kong

KENWOOD ELECTRONICS GULF FZE

P.O.Box 61318, Jebel Ali, Dubai, U.A.E.

KENWOOD ELECTRONICS SINGAPORE PTE LTD.

No. 1 Genting Lane #02-02, KENWOOD Building, Singapore, 349544

KENWOOD ELECTRONICS (MALAYSIA) SDN BHD.

#4.01 Level 4, Wisma Academy Lot 4A, Jalan 19/1 46300 Petaling Jaya Selangor Darul Ehsan Malaysia

KENWOOD ELECTRONICS (THAILAND) CO., LTD.

573/111 Soi Ramkhamhaeng 39, Ramkhamhaeng Road, Wangthonglang, Bangkok, Bangkok 10301 Thailand